

Heavy-duty Incremental Encoders (Metric-dimension Encoders)

TRD-GK series

Features

A heavy-duty encoder is the most rugged encoder you can buy. Top-of-the-line bearings allow a service life of 12 billion revolutions. Features include:

- 10 mm solid shaft
- Rugged body with 78 mm diameter and 60 mm depth
- Splash-proof IP65 rating
- Incremental operation from 30 pulses per revolution to 5,000 pulses per revolution
- 100 kHz maximum response frequency
- 10-30 VDC, Totem-pole output



Solid-shaft (TRD-GK) model

Heavy Duty Standard Shaft Incremental Encoders					
Model	Price	Pulses per Revolution	Input Voltage	Output	Body Diameter
TRD-GK30-RZD	<--->	30	10-30 VDC	Totem-pole (sink/source)	78mm
TRD-GK100-RZD	<--->	100			
TRD-GK120-RZD	<--->	120			
TRD-GK200-RZD	<--->	200			
TRD-GK240-RZD	<--->	240			
TRD-GK250-RZD	<--->	250			
TRD-GK300-RZD	<--->	300			
TRD-GK360-RZD	<--->	360			
TRD-GK400-RZD	<--->	400			
TRD-GK500-RZD	<--->	500			
TRD-GK600-RZD	<--->	600			
TRD-GK800-RZD	<--->	800			
TRD-GK1000-RZD	<--->	1000			
TRD-GK1200-RZD	<--->	1000			
TRD-GK1500-RZD	<--->	1500			
TRD-GK1800-RZD	<--->	1800			
TRD-GK2000-RZD	<--->	2000			
TRD-GK2500-RZD	<--->	2500			
TRD-GK3600-RZD	<--->	3600			
TRD-GK5000-RZD	<--->	5000			

Electrical Specifications		
Model	TRD-GKxxx-RZD	
Power Supply	Operating Voltage	10-30 VDC (nominal) * Range: 9.7-30.9 VDC
	Allowable Ripple	3% rms max.
	Current Consumption	At less than 16VDC: 50 mA max. / at 16VDC or more: 70mA max.
Output Waveform	Output Signal	Quadrature + home position
	Duty Ratio	50% ±25%
	Max. Frequency Response	100kHz max.
	Operating Speed	(max response frequency / resolution) x 60
	Signal Width at Home Position	At 400P or less: 25 to 150%; at 500P or more: 1° at 30'
	Rise/Fall Time	2µs max. (when cable length is 2m or less)
Output	Output Type	Totem-pole
	Current: Outflow: H	30mA max.
	Voltage: H	(power source voltage - 4V) min.
	Voltage: L	2V max.
	Load Power Voltage	35VDC max.
* To be supplied by Class II source		
Mechanical Specifications		
Starting Torque	Max. 0.1 N·m (0.07 ft·lbs) max. at 20°C (68°F)	
Max. Allowable Shaft Load	Radial: 100N (22.48 lbs) Axial: 50N (11.24 lbs)	
Max. Allowable Speed	5,000 rpm	
Service Life of Bearing	12 billion revolutions (at max. allowable speed)	
Wire Size	AWG24	
Weight	Approx. 600g (21.16 oz) with 2m cable	
Environmental Specifications		
Ambient Temperature	-10 to 70 °C [14 to 158 °F]	
Storage Temperature	-25 to 85 °C [-13 to 185 °F]	
Operating Humidity	35-85% RH (with no condensation)	
Insulation Resistance	50MΩ min.	
Vibration Resistance	At 500P or less: Durable for one hour along three axes at 10 to 55 Hz with 0.75 mm amplitude At 600P or more: Durable for one hour along three axes at 10 to 55 Hz with 0.35 mm amplitude	
Shock Resistance	At 500P or less: 11 ms with 980 m/s² applied three times along three axes At 600P or more: 11 ms with 294 m/s² applied three times along three axes	
Protection	IP65	

Heavy-duty Incremental Encoders (Metric-dimension Encoders)

TRD-GK series

Accessories

Couplings

For encoders with a solid shaft, please select a coupling that fits your encoder. All couplings are in stock, ready to ship.

See the "Encoder Couplings" section for more information.

Mounting Brackets

Mounting brackets for all TRD-GK encoders.

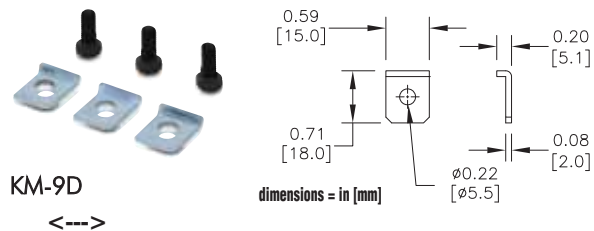
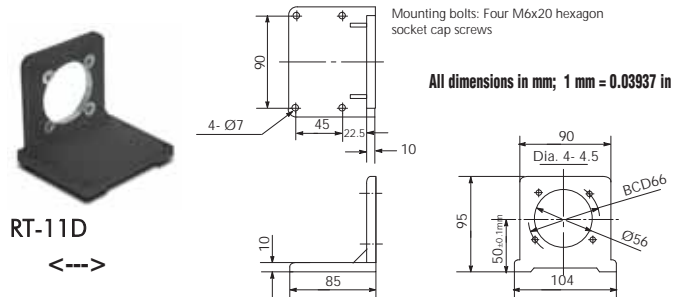

Dimensions

External dimensions

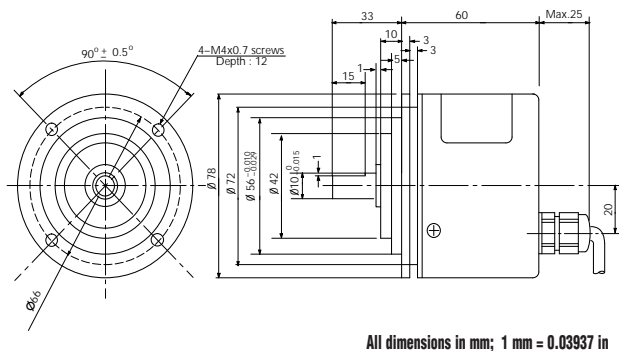

Servo mounting

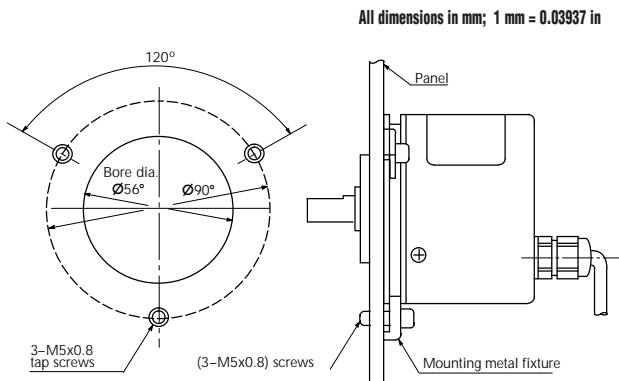

Wiring diagram

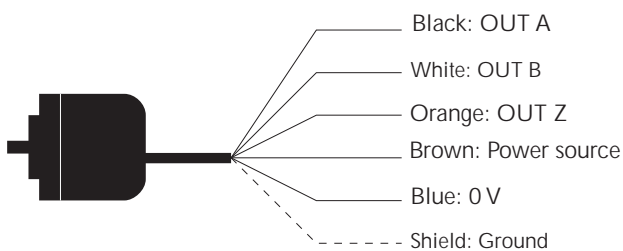

Cable shield is not connected to the encoder body; enclosure is grounded through the 0V wire.

How to read the timing charts

Totem Pole Models

Out A and Out B are 90 degrees out of phase. Like any quadrature encoder, four unique logic states are created internally to the encoder. This is based on the rising edge to rising edge (one cycle) on channel A or B that indicates one set of bars on the internal encoder disk has passed by the optical sensor.

OUT Z is the absolute reference added to an incremental encoder and is also known as home position. It signifies a full rotation of the encoder shaft.

Channel timing chart

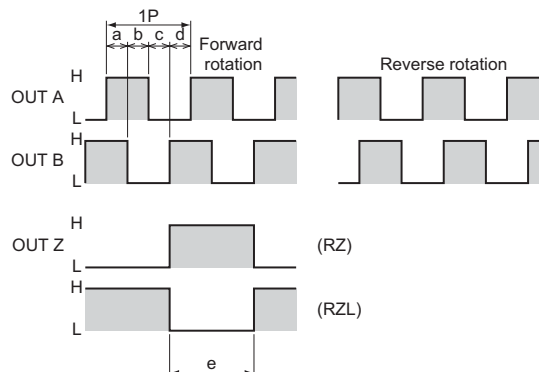

a, b, c, d = (1/4±1/8) P
e: 400 P or less: 25 to 150%
500 P or more: 1 ±30'
(At 1,800, 3,600, 5000 pulses only: 50 to 150%)

OUT Z generates home position in both directions.

Encoder Accessories – Couplings

Encoder Couplings

Couplings provide a connection between solid-shaft encoders and solid shafts. We offer aluminum, fiberglass, and polymer couplings for metric, S.A.E. and metric-to-S.A.E. applications.

Misalignment compensation

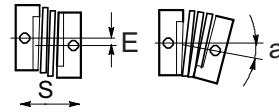

Couplings Selection Guide and Dimensions																
Type	Part Number	Price	Applicable Encoders (shaft size)	Shaft Diameter		D	L	F	C	M	a	E	S	Working Torque	Torsional Rigidity	Material
				d1	d2											
				(mm [in])							max					
Fiberglass (metric)	GJ-4D	<--->	TRD-MX (4mm)	4mm	4mm	13 [0.51]	21 [0.83]	5.3 [0.21]	3 [0.12]	M3 set screw	5°	0.4 [0.02]	0.4 [0.02]	0.6 N·m	6N·m/rad	Glass-fiber reinforced resin
	GJ-6D	<--->	TRD-S (6mm)	6mm	6mm	15 [0.59]	22 [0.87]	5.2 [0.20]	3 [0.12]	M3 set screw	6°	0.5 [0.02]	0.12 [0.005]	0.8 N·m	10 N·m/rad	
	GJ-8D	<--->	TRD-N/NA (8mm)	8mm	8mm	19 [0.75]	24 [0.94]	6.8 [0.27]	3.5 [0.14]	M4 set screw	5°	0.5 [0.02]	0.4 [0.016]	1.5 N·m	20 N·m/rad	
	GJ-10D	<--->	TRD-GK (10 mm)	10 mm	10 mm	22 [0.87]	26 [1.02]	7.1 [0.28]	4 [0.16]	M4 set screw	5°	0.5 [0.02]	0.12 [0.005]	2.0 N·m	32 N·m/rad	
Fiberglass (SAE)	GJ-635D	<--->	TRDA-2E (0.25 in)	0.25 in	0.25 in	15 [0.59]	22 [0.87]	5.2 [0.20]	3 [0.12]	M3 set screw	5°	0.5 [0.02]	0.12 [0.005]	0.8 N·m	10 N·m/rad	Glass-fiber reinforced resin
	GJK-953D	<--->	TRDA-20/25 (0.375 in)	0.375 in	0.375 in	25 [0.98]	32 [1.26]	7.3 [0.29]	3.5 [0.14]	M4 set screw	5°	0.5 [0.02]	0.12 [0.005]	2.0 N·m	32 N·m/rad	
Polymer (SAE)	STP-MTRA-SC-1412	<--->	TRDA-2E (0.25 in)	0.25 in	0.50 in	25 [0.98]	38 [1.50]	9.9 [0.39]	5.4 [0.21]	M3 cap screw	5°	0.3 [0.01]	0.12 [0.005]	3.7 N·m	0.36 °/lb·in	Engineered polymer
	STP-MTRA-SC-3812	<--->	TRDA-20/25 (0.375 in)	0.375 in	0.50 in	25 [0.98]	38 [1.50]	9.9 [0.39]	5.4 [0.21]	M3 cap screw	5°	0.3 [0.01]	0.12 [0.005]	3.7 N·m	0.36 °/lb·in	
Aluminum (metric)	ARM-075-5-4D	<--->	TRD-MX (4mm)	4mm	5mm	19.1 [0.75]	19.1 [0.75]	4.6 [0.18]	2.4 [0.09]	M3 set screw	5°	0.25 [0.01]	0.25 [0.01]	2.3 N·m	8.2 N·m/rad	Aluminum alloy
	RU-075D	<--->	TRD-S (6mm)	6mm	6mm	19.1 [0.75]	19.1 [0.75]	4.6 [0.18]	2.4 [0.09]	M3 set screw	5°	0.25 [0.01]	0.12 [0.005]	1.0 N·m	8.2 N·m/rad	
	JU-100D	<--->	TRD-N/NA (8mm)	8mm	8mm	25.4 [1.00]	25.4 [1.00]	6.6 [0.26]	3.8 [0.15]	M5 set screw	5°	0.25 [0.01]	0.25 [0.010]	1.6 N·m	14.3 N·m/rad	
	RU-100D	<--->	TRD-GK (10 mm)	10 mm	10 mm	25.4 [1.00]	25.4 [1.00]	6.6 [0.26]	3.8 [0.15]	M5 set screw	5°	0.25 [0.01]	0.12 [0.005]	1.6 N·m	14.3 N·m/rad	
Aluminum (metric-to-SAE)	ML13P-4-476D	<--->	TRD-MX (4mm)	4mm	0.1875 in	13 [0.51]	19 [0.75]	5.5 [0.22]	2.5 [0.10]	M2 set screw	5°	0.4 [0.02]	0.2 [0.01]	0.25 N·m	44 N·m/rad	Aluminum alloy (Bent plate: Polymide)
	ML16P-4-635D	<--->	TRD-MX (4mm) TRDA-2E (0.25 in)	4mm	0.25 in	16 [0.63]	23 [0.91]	7 [0.28]	3 [0.12]	M3 set screw	5°	0.6 [0.02]	0.3 [0.01]	0.4 N·m	70 N·m/rad	
	MCGL16-6-635	<--->	TRD-S (6mm) TRDA-2E (0.25 in)	6mm	0.25 in	16 [0.63]	23.2 [0.91]	7 [0.28]	3 [0.12]	M3 set screw	3.5°	0.3 [0.01]	0.3 [0.01]	0.4 N·m	70 N·m/rad	
	MCGL20-8-635	<--->	TRD-N/NA (8mm) TRDA-2E (0.25 in)	8mm	0.25 in	20 [0.79]	26 [1.02]	7.5 [0.30]	3.7 [0.15]	M3 set screw	3.5°	0.3 [0.01]	0.4 [0.02]	0.6 N·m	130 N·m/rad	
	MCGL20-8-952	<--->	TRD-N/NA (8mm) TRDA-20/25 (0.375 in)	8mm	0.375 in	20 [0.79]	26 [1.02]	7.5 [0.30]	3.7 [0.15]	M3 set screw	3.5°	0.3 [0.01]	0.4 [0.02]	0.6 N·m	130 N·m/rad	
	MCGL25-10-635	<--->	TRD-GK (10 mm) TRDA-2E (0.25 in)	10 mm	0.25 in	25 [0.98]	30.2 [1.19]	9 [0.35]	4 [0.16]	M4 set screw	3.5°	0.3 [0.01]	0.5 [0.02]	1.4 N·m	240 N·m/rad	
	MCGL25-10-952	<--->	TRD-GK (10 mm) TRDA-20/25 (0.375 in)	10 mm	0.375 in	25 [0.98]	30.2 [1.19]	9 [0.35]	4 [0.16]	M4 set screw	3.5°	0.3 [0.01]	0.5 [0.02]	1.4 N·m	240 N·m/rad	
Aluminum (SAE)	ARM-075-635-635D	<--->	TRDA-2E (0.25 in)	0.25 in	0.25 in	19.1 [0.75]	19.1 [0.75]	4.6 [0.18]	2.4 [0.09]	M3 set screw	5°	0.25 [0.01]	0.25 [0.01]	1.0 N·m	8.2 N·m/rad	Aluminum alloy
	ARM-100-9525-9525D	<--->	TRDA-20/25 (0.375 in)	0.375 in	0.375 in	25.4 [1.00]	25.4 [1.00]	6.6 [0.26]	3.8 [0.15]	M5 set screw	5°	0.25 [0.01]	0.25 [0.01]	1.6 N·m	14.3 N·m/rad	

* mm ÷ 25.4 = inches

Encoder Accessories – Couplings

Encoder Couplings – Dimensions

GJ-xxD Fiberglass Couplings (metric) & GJx-xxxD Fiberglass Couplings (SAE)

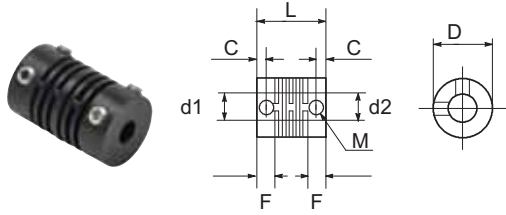

STP-MTRA-SC-xxxx Polymer Couplings

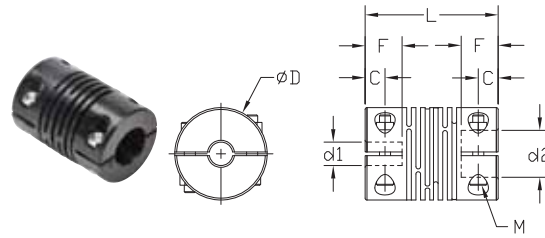

ARM-xxxxxD Aluminum Couplings (metric & SAE)

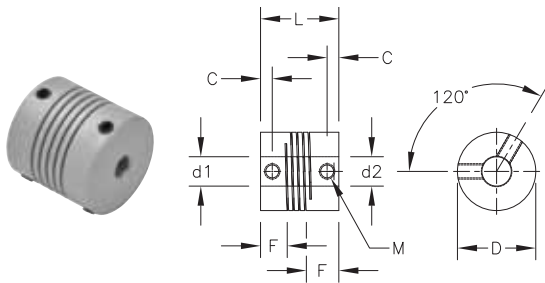

MCGLx Aluminum Couplings & ML1xP-4-xxxD Aluminum Couplings

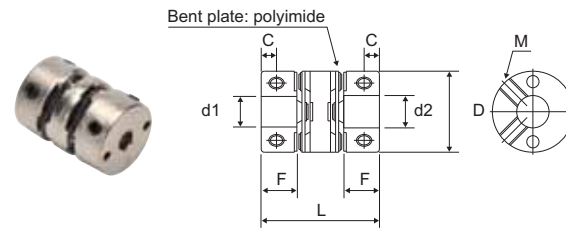

RU-075D, RU-100D, and JU-100D Aluminum Couplings

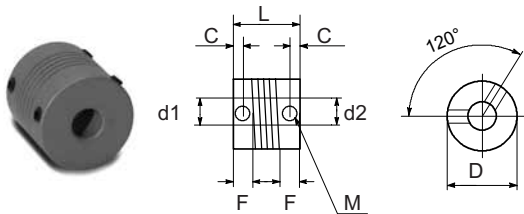

Great Encoder Selection at Great Prices



- Company Information
- Systems Overview
- Programmable Controllers
- Field I/O
- Software
- C-more & other HMI
- Drives
- Soft Starters
- Motors & Gearbox
- Steppers/Servos
- Motor Controls
- Proximity Sensors
- Photo Sensors
- Limit Switches
- Encoders**
- Current Sensors
- Pressure Sensors
- Temperature Sensors
- Pushbuttons/Lights
- Process
- Relays/Timers
- Comm.
- Terminal Blocks & Wiring
- Power
- Circuit Protection
- Enclosures
- Tools
- Pneumatics
- Safety
- Appendix
- Product Index
- Part # Index



Koyo®

Heavy-duty TRD-GK

Medium Duty TRD-NH

Medium Duty TRD-N

Medium Duty TRDA-25 (w/MS connector)

Light-duty TRD-MX

	Duty	Family	Size	Encoder diameter	Shaft diameter	Solid or Hollow Shaft	Operating Voltage (VDC) and Electrical Output*	IP Rating	Max Radial Load (N)	Max Axial Load (N)	Available resolutions
Incremental	Light Duty	TRD-MX	10	25mm	4mm	solid	5V Line Driver or 5-12V OC or 12-24V OC	IP50	10	5	100, 360, 500, 1000, 1024
		TRDA-2E	15	1.5"	1/4"	solid	5V Line Driver or 12-24V OC	IP50	30	20	100, 360, 500, 1000, 1024, 2500
		TRD-S	15	38mm	6mm	solid	5V Line Driver or 12-24V OC	IP40	20	10	100, 200, 250, 300, 360, 400, 500, 600, 800, 1000, 1024, 1200, 2000, 2500
		TRD-SH	15	38mm	8mm	hollow	5V Line Driver or 12-24V OC	IP40	20	10	100, 200, 250, 300, 360, 400, 500, 600, 800, 1000, 1024, 1200, 2000, 2500
	Medium Duty	TRDA-20	20	2"	3/8"	solid	5V Line Driver or 5-30V P/P	IP50	50	30	100, 360, 500, 1000, 1024, 2500
		TRDA-25	25 (w/size 20 body)	2.5" flange (w/ 2.0" body)	3/8"	solid	5V Line Driver or 5-30V P/P	IP65	50	30	100, 360, 500, 1000, 1024, 2500
		TRD-N	20	50mm	8mm	solid	5V Line Driver or 5-30V P/P	IP65	50	30	3, 4, 5, 10, 30, 40, 50, 60, 100, 120, 200, 240, 250, 300, 360, 400, 480, 500, 600, 750, 1000, 1024, 1200, 2000, 2500, 3000, 3600, 5000
		TRD-NH	20	50mm	8mm	hollow	5V Line Driver or 5-30V P/P	IP65	50	30	3, 4, 5, 10, 30, 40, 50, 60, 100, 120, 200, 240, 250, 300, 360, 400, 480, 500, 600, 750, 1000, 1024, 1200, 2000, 2500, 3000, 3600, 5000
	Heavy Duty	TRD-GK	30	78mm	10mm	solid	10-30V P/P	IP65	100	50	30, 100, 120, 200, 240, 250, 300, 360, 400, 500, 600, 800, 1000, 1200, 1500, 1800, 2000, 2500, 3600, 5000
		Medium Duty Absolute	TRD-NA	20	50mm	8mm	solid	10-30V OC	IP65	50	30

All our encoders feature an integral 2m cable except for the TRDA-25 series which has an MS connector

*Operating Voltage and Electrical Output:
 • LD = Line Driver (all Line Drivers require 5VDC supply)
 • OC = NPN Open Collector (at Operating Voltage)
 • P/P = Push Pull or Totem Pole (at Operating Voltage)

Accessories

Couplings

A variety of couplings - metric-to-metric, inch-to-inch (SAE - SAE), and metric-to-inch are in stock, ready to ship.



Flanges

A collection of flanges that ease encoder mounting. Several models are available with round flanges, square flanges and miscellaneous mounting options.

Mounting brackets

Simplify your installation with a ready-to-use right-angle mounting bracket for light, medium and heavy-duty encoders



Cables

For encoders that require a connector cable, we have cables in stock, priced right and ready to ship.

